

# SKYJACK™

## OPERATING MANUAL

This manual MUST be kept and stored with the aerial platform at all times.

# SJIII Series

## The Compacts And Conventionals

Models 3015, 3219, 3220, 3226, 4620,  
4626, 4830, 4832, 6826, And 6832



**For Service please call ..... 800 275-9522**

Skyjack Inc. Service Center 3451 Swenson Ave., St. Charles, IL. 60174 ..... FAX 630 262-0006

**For Parts in North America and Asia please call ..... 800 965-4626**

Skyjack Inc. Parts Center 3451 Swenson Ave., St. Charles, IL. 60174 ..... FAX 888 782-4825

**For Parts & Service in Europe please call ..... 31 297 255 526**

Skyjack Europe Communicatieweg 29, 3641 SG Mijdrecht Netherlands ..... FAX 31 297 256 948



## WARNING

This Operating Manual and the “ANSI/SIA Manual Of Responsibilities” are considered fundamental parts of the elevating work platform. They are a very important way to communicate necessary safety information to users and operators. A complete and legible copy of these manuals **MUST BE KEPT ON THE WORK PLATFORM** in the provided weather resistant storage compartment at all times.

Before using or operating this work platform, check to see if it is equipped with any special options or has been modified in any way (refer to Table 2-5. for a list of Skyjack special options). Read all the applicable operating instructions and warnings. If this manual does not contain the required operating instructions for the special option(s), refer to Table 2-5. and order the appropriate sheet(s).

**DO NOT OPERATE THIS EQUIPMENT WITHOUT PROPER AUTHORIZATION, TRAINING AND UNDERSTANDING OF THE OPERATION OF BOTH STANDARD AND OPTIONAL EQUIPMENT. DO NOT USE A WORK PLATFORM THAT HAS OPTIONS, ALTERATIONS OR MODIFICATIONS NOT APPROVED BY SKYJACK.**

USE THE SERIAL NUMBER OF YOUR MACHINE TO DETERMINE THE CORRECT OPERATING MANUAL TO USE							
MANUAL PART #	118942AD	122882AJ	122908AE	129908AE	129917AC (CE)	129918AC (ANSI/CSA)	129939AA (AU)
Release Date	July 2003	July 2003	July 2003	July 2003	May 2005	May 2005	May 2005
M O D E L S	3015	150931 & Below	150932 to 115980	Not Used		Not Used	
	3219	229632 & Below	229633 to 236285	Not Used		Not Used	
	3215	Not Used		115981 to 152099	152100 to 152169	152170 & Above	
	3219	Not Used		236286 to 237573	237574 to 239691	239692 & Above	244130 & Above
	3220	611286 & Below	611287 to 613550	613551 to 615016	615017 to 615505	615506 & Above	616430 & Above
	3226	Not Used	27013 to 28042 28048 to 28117	28043 to 28047 28118 to 270930	270931 to 271776	271777 & Above	
	4620	66658 & Below	66659 to 66875	Not Used		66876 to 66889	710000 & Above
	4626	706174 & Below	706175 to 709362	Not Used		709363 to 709588	
	4632	Not Used		Not Used		Not Used	Not Used
	4830/32	87564 & Below	87565 to 870780	Not Used		870781 to 871159	
	6826	75578 & Below	75579 to 75618	Not Used		75619 to 75619	75620 & Above
	6832	82573 & Below	82574 to 83066	Not Used		83067 to 83100	83101 & Above

60312AD

# Table Of Contents

<u>Section - Paragraph</u>	<u>Page No.</u>
<b>Section 1 - Introduction</b>	
Purpose Of Equipment .....	7
Use Of Equipment .....	7
Warnings .....	7
Description .....	7
Operator Warnings .....	8
Specifications And Features .....	9, 10
Standard Features And Optional Equipment .....	11
Work Platform Major Component Identification .....	12
<b>Section 2 - Operation</b>	
<b>Operating Controls Identification</b> .....	<b>13</b>
Base Controls .....	13
Electrical Panel .....	13
Emergency Battery Disconnect Switch .....	13
Base Control Box .....	13
Platform Controls .....	14
Operators's Control Box .....	14
Powered Extension Platform Control Box .....	14
Identification And Operation Of Safety Devices .....	15
Operator Qualifications .....	16
<b>Operating Procedures</b> .....	<b>17</b>
Set-Up Procedure .....	17
Prestart Checks .....	18
Start and Operation .....	19
Emergency Lowering System .....	21
Shutdown Procedure .....	21
Winching and Towing Procedures .....	22
Battery Service And Charging Procedures .....	24
Battery Charger Operation .....	25
Battery Charger 2.1 .....	25
Battery Charger 2.2 .....	26
Battery Charger 2.3 .....	27

## List Of Tables

Table 1-1A. Specifications And Features- The Conventionals .....	Section 1, Page 9
Table 1-1B. Specifications And Features- The Compacts .....	Section 1, Page 10
Table 1-2. Standard Features And Optional Equipment .....	Section 1, Page 11
Table 2-1. Owner's Annual Inspection Record .....	Section 2, Page 28
Table 2-2. Maximum Platform Capacities .....	Section 2, Page 28
Table 2-3. Maintenance And Inspection Schedule .....	Section 2, Page 29
Table 2-4A. Floor Loading Pressure (SJIII Conventionals) .....	Section 2, Page 30
Table 2-4B. Floor Loading Pressure (SJIII Compacts) .....	Section 2, Page 30
Table 2-5. SJIII Special Option Information .....	Section 2, Page 31
Table 2-6. Limmit Switch Settings .....	Section 2, Page 31

 **WARNING**

**ANSI/SIA (United States)**

You are required by the current ANSI/SIA A92.6 standards to read and understand **YOUR RESPONSIBILITIES** in the Manual Of Responsibilities before you use or operate this work platform.

**CSA (Canada) and CE (Europe)**

You are required to conform to national health and safety regulations applicable to the operation of this elevating work platform.

**FAILURE TO COMPLY with your REQUIRED RESPONSIBILITIES in the use and operation of the work platform could result in DEATH OR SERIOUS INJURY!**

**OPERATOR SAFETY REMINDERS**

The National Safety Council reminds us that most accidents are caused by the failure of some individuals to follow simple and fundamental safety rules and precautions. Common sense dictates the use of protective clothing when working on or near machinery. Use appropriate safety devices to protect your eyes, ears, hands, feet and body.

You, as a careful operator, are the best insurance against an accident. Therefore, proper usage of this work platform is mandatory. The following pages of this manual should be read and understood completely before operating the work platform. Any modifications from the original design are strictly forbidden without written permission from SKYJACK, Inc.

 **DANGER**

**ELECTROCUTION HAZARD**

**THIS MACHINE IS NOT INSULATED. MAINTAIN SAFE CLEARANCES FROM ELECTRICAL POWER LINES AND APPARATUS. YOU MUST ALLOW FOR PLATFORM SWAY, ROCK OR SAG. THIS WORK PLATFORM DOES NOT PROVIDE PROTECTION FROM CONTACT WITH OR PROXIMITY TO AN ELECTRICALLY CHARGED CONDUCTOR.**

Minimum Safe Approach Distance

ANSI/SIA A92.6-1999 & CSA CAN3-B354.2&.3-M82 Requirements			CE Guidance Note
Voltage Range (Phase to Phase)	Minimum Safe Approach Distance		"Avoidance of danger from Overhead Lines"  These machines should not operate within 15M of overhead lines suspended from steel towers.  These machines should not operate within 9M of overhead lines suspended from wooden poles.
	Feet	Meters	
0 To 300V	Avoid Contact		
Over 300V to 50KV	10	3.05	
Over 50KV to 200KV	15	4.60	
Over 200KV to 350KV	20	6.10	
Over 350KV to 500KV	25	7.62	
Over 500KV to 750KV	35	10.67	
Over 750KV to 1000KV	45	13.72	

**FAILURE TO AVOID THIS HAZARD WILL RESULT IN DEATH OR SERIOUS INJURY!**

**DO NOT OPERATE THIS EQUIPMENT WITHOUT PROPER AUTHORIZATION AND TRAINING. DEATH OR SERIOUS INJURY COULD RESULT FROM IMPROPER USE OF THIS EQUIPMENT!**

### **SERVICE POLICY AND WARRANTY**

SKYJACK, Inc. warrants each new SJIII Series work platform to be free of defective parts and workmanship for the first 12 months. Any defective part will be replaced or repaired by your local SKYJACK dealer at no charge for parts or labor. [Refer to Warranty Statement](#) for extensions or exclusions.

#### **NOTE**

SKYJACK, Inc. is continuously improving and expanding product features on it's equipment: therefore, specifications and dimensions are subject to change without notice.



**This Safety Alert Symbol Means Attention!**

**Become Alert! Your Safety Is Involved.**

The Safety Alert Symbol identifies important safety messages on machines, safety signs, in manuals, or elsewhere. When you see this symbol, be alert to the possibility of personal injury or death. Follow the instructions in the safety message.

### **SCOPE OF THIS MANUAL**

This manual applies to the ANSI/SIA, CSA and CE versions of the SJIII Series work platform models listed on [Table 1-1](#). Equipment identified with "ANSI" meet ANSI/SIA-A92.6 -1999 standards. Equipment identified with "CSA" meets the CAN3-B354.2&.3-M82 standards. Equipment identified with "CE" meets the requirements for the European countries, i.e. Machinery Directive 89/392/EEC and EMC Directive 89/336/EEC and the corresponding EN standards.

## WARRANTY STATEMENT

SKYJACK, Inc. warrants each new work platform to be free of defective parts and workmanship. During the first full year, labor and replacement parts will be provided by the local authorized Skyjack dealer without charge. For the following 48 months, structural components found to be defective will be replaced or repaired at no charge.

A warranty registration card is supplied with each work platform. The warranty is only effective when the warranty card has been completed and returned to Skyjack within 15 days from the time of billing. When work platforms are put into stock, the warranty period does not start until the work platform has been shipped to the dealers customer. If a unit is put into service and no warranty card has been mailed to Skyjack, Inc., the warranty period will commence 15 days from the date the dealer was invoiced for the work platform.

All warranty claims are subject to approval by Skyjack's Service Department. Skyjack, Inc. reserves the right to limit or adjust claims with regard to defective parts, labor or travel time based on usual and customary guidelines. Parts purchased from sources other than Skyjack will not be covered under this warranty. Misuse or improper operation, lack of normal maintenance and inspections as outlined in this Operating/Maintenance and Parts Manual, alterations to original design and/or components or accidents will void all warranty. **Batteries are not covered by this warranty.**

The above mentioned warranty statement is exclusive and no other warranty whether written, oral or implied shall apply. Skyjack excludes any implied warranty of merchantability and fitness and accepts no liability for consequential damages or for other negligence.

### WARRANTY PROCEDURES

The selling distributor or authorized dealer shall be responsible for the complete handling of customer claims under this warranty. Here's what to do:

1. When a customer files a claim under this warranty, contact Skyjack's Service Department to verify warranty coverage. **NOTE:** The complete serial number of the work platform is required to verify the claim.
2. When Skyjack's Service Department verifies warranty coverage, they will also issue an RA (Return Authorization) number for the return of any defective component(s). All items over \$25.00 in value must be returned to Skyjack, Inc.
3. Fill out a Warranty Claim Form from dealer's supply of claim forms. Then notify Skyjack's Service Department of the warranty claim number on the form used.
4. The distributor/dealer should then file a warranty claim with Skyjack, Inc. describing the nature of the defect, probable cause, work performed, travel hours, and labor hours listed separately. Warranty labor will be paid at a rate of \$42.00 per hour. The travel allowance will be paid at the same hourly rate within the dealers specified territory, limited to a maximum of four (4) hours. If a part has serviceable components, **PLEASE** replace the bad component. For instance, if you have a bad switch on a controller, please replace the switch. Hydraulic cylinders should be resealed, unless they are damaged beyond repair. Engine failures should be directed to your local engine distributor and covered by the manufacturers warranty. Skyjack will accommodate you and your labor. Labor rates and travel allowances are subject to change without notice.
5. Warranty claims must be received by Skyjack within 15 working days from the date of the repair. Warranty claims received with insufficient information will be returned for correction or completion.
6. Materials returned for warranty inspection must have the following procedures:
  - A. Carefully packaged to prevent additional damage during shipping.
  - B. Drained of all contents and all open ports capped or plugged.
  - C. Shipped in a container tagged or marked with the RA number.
  - D. Shipped **PREPAID**. Any item(s) returned for warranty by any other means may be refused and returned unless prior approval from Skyjack is obtained.
  - E. Items shipped to the dealer will be sent freight prepaid and added to the invoice.

Failure to comply with the above procedures may delay approval and processing of the warranty claim and could result in the denial of a warranty claim. Skyjack's dealer's accounts must be kept current in order to approve and issue warranty credits. Skyjack reserves the right to withhold issuance of warranty credits to a dealer if their account is not in good standing. This is subject to change without prior notice.

# SECTION 1

## INTRODUCTION

### Purpose Of Equipment

The SKYJACK SJIII Series Work Platform is designed to transport and raise personnel, tools and materials to overhead work areas.

### Use Of Equipment

The work platform (Figure 1-1.) is a highly maneuverable, mobile work station. Lifting and driving **MUST** be on a flat, level, compacted surface.

### Warnings

The operator **MUST** read and completely understand the safety panel label located on the platform and **ALL** other warnings in this manual and on the work platform. Compare the labels on the work platform with the labels found throughout this manual. If any labels are damaged or missing, replace them immediately.

### Description

The work platform consists of three major assemblies, the platform, lifting mechanism and the base. An operator's control box is mounted on the platform railing. Auxiliary and emergency controls are located at the base.

### Platform

The platform is constructed of a tubular support frame, a skid-resistant deck surface, and 40 inch to 43-1/2 inch (1016-1105mm) high railings (depending on model) with 6" (152mm) toe boards and mid-rails. The platform can be entered from the rear through an entry chain or optional spring-returned gate with latch. The platform is also equipped with an extension platform.

### Manual Storage Box

This weather resistant box is mounted at the front of the platform directly below the safety panel. It contains the Operating Manual, Operating/Maintenance and Parts Manual and other important documentation. The Operating Manual for this make and model work platform **MUST** remain with the work platform and should be stored in this box.



### Operator's Control Box

A removable control box, mounted at the right front of the platform, contains controls for work platform motion and emergency stopping.

### Lifting Mechanism

The lifting mechanism is constructed from steel tubing making up a scissor-type assembly. The scissor-type assembly is raised and lowered by single-acting hydraulic lift cylinders. A pump, driven by a motor, provides hydraulic power to the lift cylinder. **A safety bar** located at the front of the lifting mechanism prevents (when properly positioned) the scissor-type assembly from being lowered while maintenance or repairs are being performed within the lifting mechanism.

### Base

The base is a rigid one-piece weldment which supports two swing-out trays. **On Models 3015, 3219, 3220, 3226, 4620, 4626 and 4832** a mechanically actuated angle, located under the outside of the trays, rotates when lifting. This mechanism provides pothole protection for elevated driving. One tray contains the hydraulic and electrical components. The other tray contains the battery charger and four (4) 6 volt batteries. **On Models 3015 and 3219;** the front axle has two hydraulic motor-driven wheels, steerable by a hydraulic cylinder. The rear axle is fixed and has two spring-applied hydraulically-released parking brakes. **On Models 3220, 3226, 4620, 4626, 4832, 6826 and 6832** The front axle has two non-driven wheels, steerable by a hydraulic cylinder. The rear axle has two hydraulic motor-driven wheels and two spring-applied hydraulically-released parking brakes.

### Lowering Warning System (CE only)

**Models 3015, 3219, 3220, 3226, 4620, 4626 and 4832** are equipped with a lowering warning system as standard equipment.

### Scissor Guards (CE only)

**Models 6826 and 6832** are equipped with rigid scissor guards mounted on the base as standard equipment.

### Serial Number Nameplate

The serial number nameplate, located at the rear of the machine, lists the model number, serial number, machine weight, drive height, capacity and maximum no. of persons, maximum speed, maximum manual force, maximum incline, platform height, voltage, system pressure, lift pressure, ground pressure (tire contact pressure), and date manufactured. Use this information for proper operation and maintenance and when ordering service parts.

## Optional Accessories

The SKYJACK SJIII Series Work Platform is designed to accept a variety of optional accessories. These are listed in (Table 1-2.) Standard Features and Optional Equipment. Operating instructions for these options (if required) are located in Section 2 of this manual.

## Operator Warnings

### Warning

- DO NOT** exert excessive side forces on platform while elevated.
- DO NOT** overload, the lift relief valve does not protect against overloading when the platform is elevated.
- DO NOT** alter or disable limit switches or other safety devices.
- DO NOT** exceed the rated capacity of your scissorlift and make sure the load is evenly distributed on the platform.
- DO NOT** raise your platform in windy or gusty conditions.

### Warning Jobsite Hazards

- DO NOT** operate on surfaces not capable of holding weight of the work platform including the rated load, e.g. covers, drains, and trenches.
- DO NOT** elevate the work platform if it is not on firm level surfaces. Avoid pot holes, loading docks, debris, drop offs and surfaces that may affect the stability of your work platform.
- DO NOT** climb or descend a grade steeper than 20% (3015, 3219 & 4832) or 25% (3220, 3226, 4620, 4626, 6826 & 6832). Elevated driving must only be done on firm level surfaces. (Ref. Table 1-1)
- BE AWARE** of overhead obstacles, and poorly lit areas in case of overhead obstacles.
- ENSURE** that there is no person(s) in the path of travel.

### Warning

## Work Platform Conditions

### **An Operator Should Not Use Any Work Platform That :**

- Has ladders, scaffolding or other devices mounted on it to increase its size or work height.
- Does not have a clean, uncluttered work area.
- Does not appear to be working properly.
- Has been damaged or appears to have worn or missing parts.
- Has alterations or modifications not approved by the manufacturer.
- Has safety devices which have been altered or disabled.



**Table 1-1a. Specifications and Features - The Conventionals**

<b>Model</b>	<b>3220</b>	<b>3226</b>	<b>4620</b>	<b>4626</b>	<b>4832</b>	<b>6826</b>	<b>6832</b>
<b>Weight</b> Ω	3920 lbs. (1778 kg)	Ω	3670 lbs. (1665 kg)	4850 lbs. (2200 kg)	5290 lbs. (2400 kg)	5310 lbs. (2409 kg)	5610 lbs. (2545 kg)
<b>Width</b>	32.00" (0.81m)	32.00" (0.81m)	46.00" (1.17m)	46.00" (1.17m)	48.00" (1.22m)	68.00" (1.73m)	68.00" (1.73m)
<b>Length</b>	89.00" (2.26m)	89.00" (2.26m)	89.00" (2.26m)	89.00" (2.26m)	89.00" (2.26m)	99.25" (2.52m)	99.25" (2.52m)
<b>Elevated Working Height</b>	26.00' (7.92m)	32.00' (9.75m)	26.00' (7.92m)	32.00' (9.75m)	38.00' (11.60m)	32.00' (9.75m)	38.00' (11.60m)
<b>Elevated Platform Height</b>	20.00' (6.10m)	26.00' (7.92m)	20.00' (6.10m)	26.00' (7.92m)	32.00' (9.75m)	26.00' (7.92m)	32.00' (9.75m)
<b>Stowed Fixed Railing Height</b>	79.1" (2.00m)	86.1" (2.19 m)	79.1" (2.00m)	88.6" (2.25m)	92.50" (2.35m)	93.60" (2.37m)	99.00" (2.51m)
<b>Stowed Platform Height</b>	38.0" (.97 m)	45.1" (1.15 m)	38.0" (.97 m)	45.0" (1.14 m)	48.5" (1.23 m)	50.0" (1.27 m)	55.3" (1.40 m)
<b>Drive Height</b>	Refer to "Table 2-6. Limit Switch Settings"						
<b>Platform Size</b>	28" x 81" (0.71x2.05m)	28" x 81" (0.71x2.05m)	42" x 81" (1.07x2.05m)	42" x 81" (1.07x2.05m)	42" x 81" (1.07x2.05m)	60" x 81" (1.53x2.05m)	60" x 81" (1.53x2.05m)
<b>High Travel Speed</b>	2 mph (3.2 km/h)	2.4 mph (3.9 km/h)	2 mph (3.2 km/h)	2 mph (3.2 km/h)	2 mph (3.2 km/h)	2 mph (3.2 km/h)	2 mph (3.2 km/h)
<b>Elevated Drive Speed</b>	.67 mph (1 km/h)	.46 mph (0.74 km/h)	.67 mph (1 km/h)	.67 mph (1 km/h)	.67 mph (1 km/h)	.67 mph (1 km/h)	.40 mph (0.64 km/h)
<b>High Torque Drive Speed</b>	1 mph (1.6 km/h)	1.33 mph (2.14 km/h)	1 mph (1.6 km/h)	1 mph (1.6 km/h)	1 mph (1.6 km/h)	1 mph (1.6 km/h)	1 mph (1.6 km/h)
<b>Lift Time (Rated Load)</b>	33 sec.	58 sec.	36 sec.	53 sec.	Not Available	59 sec.	58 sec.
<b>Lower Time (Rated Load)</b>	29 sec.	55 sec.	36 sec.	40 sec.	Not Available	44 sec.	51 sec.
<b>Gradability</b>	25%	25%	25%	25%	20%	25%	25%
<b>Tires</b>	16 x 4 x 8 Solid Rubber	16 x 4.5 x 12 Solid Rubber	16 x 4 x 8 Solid Rubber	16 x 4 x 8 Solid Rubber	16 x 4 x 8 Solid Rubber	23 x 10.5 x 12 Foam Filled*	23 x 10.5 x 12 Foam Filled*

Ω Weight with standard 3' (0.9m) extension platform. Refer to Serial Nameplate for specific applications.  
(Refer to nameplate for machines with 5' (1.5m) or 6' (1.8m) extension platform, CE models and other options.)

\* Fill Hardness: 55 Durometer

**Table 1-1b. Specifications and Features - The Compacts**

<b>Model</b>	<b>3015</b>	<b>3219</b>
<b>Weight</b> Ω	2360 lbs. (1070 kg)	2790 lbs. (1266 kg)
<b>Width</b>	30.50" (0.77m)	32.50" (0.83m)
<b>Length</b>	66.50" (1.69m)	66.50" (1.69m)
<b>Elevated Working Height</b>	21.00' (6.4m)	25.00' (7.6m)
<b>Elevated Platform Height</b>	15.00' (4.6m)	19.00' (5.80m)
<b>Stowed Fixed Railing Height</b>	78.0" (1.98m)	79.0" (2.01m)
<b>Drive Height</b>	Refer to "Table 2.6. Limit Switch Settings"	
<b>Platform Size</b>	28" x 64" (0.71x1.63m)	28" x 64" (0.71x1.63m)
<b>High Travel Speed</b>	2 mph (3.2 km/h)	2 mph (3.2 km/h)
<b>Elevated Drive Speed</b>	.75 mph (1.2 km/h)	.75 mph (1.2 km/h)
<b>Lift Time (No Load)</b>	21 sec.	30 sec.
<b>Lower Time (No Load)</b>	29 sec.	40 sec.
<b>Gradability</b>	20%	20%

Ω Weight with standard 3' (0.9m) extension platform.  
(Refer to nameplate for machines with 3' (0.9m) powered extension platform, CE models and other options.)

**Table 1-2. Standard Features And Optional Equipment**

**Standard Features (ANSI & CE)**

- Descent Alarm
- Joystick Controller With Proportional Lift and Drive Functions (See NOTE)
- Swing Out Side Trays
- Dual Spring-Applied, Hydraulically-Released Parking Brakes
- Puncture-Proof Solid Rubber Non-Marking Tires (All Models Except 6826 and 6832)
- Urethane Foam Filled Tires (Models 6826 and 6832)
- Manual Lowering System With Electric Holding Valves On Lift Cylinders
- Pothole Protection (All Models Except 6826 and 6832)
- Operator Horn
- 3 Foot Manual Extension Platform
- AC Outlet On Platform
- Lanyard Attachment Rings
- Scissor Guards (CE only) (Models 6826 and 6832)
- Lowering Warning System (CE only) (All Models Except 6826 and 6832)
- Front Wheel Drive With Tight Turning Radius (Models 3015 and 3219)
- Spring-Loaded Half-Height Gate (CE only)
- Movement Alarm (ANSI only)

**Optional Equipment (ANSI & CE)**

- Spring-Loaded Half-Height Gate (ANSI only)
- Spring-Loaded Full-Height Gate
- Movement Alarm (CE only)
- Flashing Amber Light
- 800W AC Generator
- Hydraulically Powered Extension Platform
- EE-Rating
- Air (Power) Package (All Models Except 3015 and 3219)
- Shop Air Hose To Platform
- Scissor Guards (ANSI only) (Models 6826 and 6832)
- Puncture-Proof Solid Rubber Black Tires (All Models Except 6826 and 6832)
- Lowering warning system (ANSI only)
- Propane or Diesel Engine Package (All Models Except 3015, 3219, 3220 and 3226)

**Note:** Platform lowering and steering are not proportional.

## Work Platform Major Component Identification

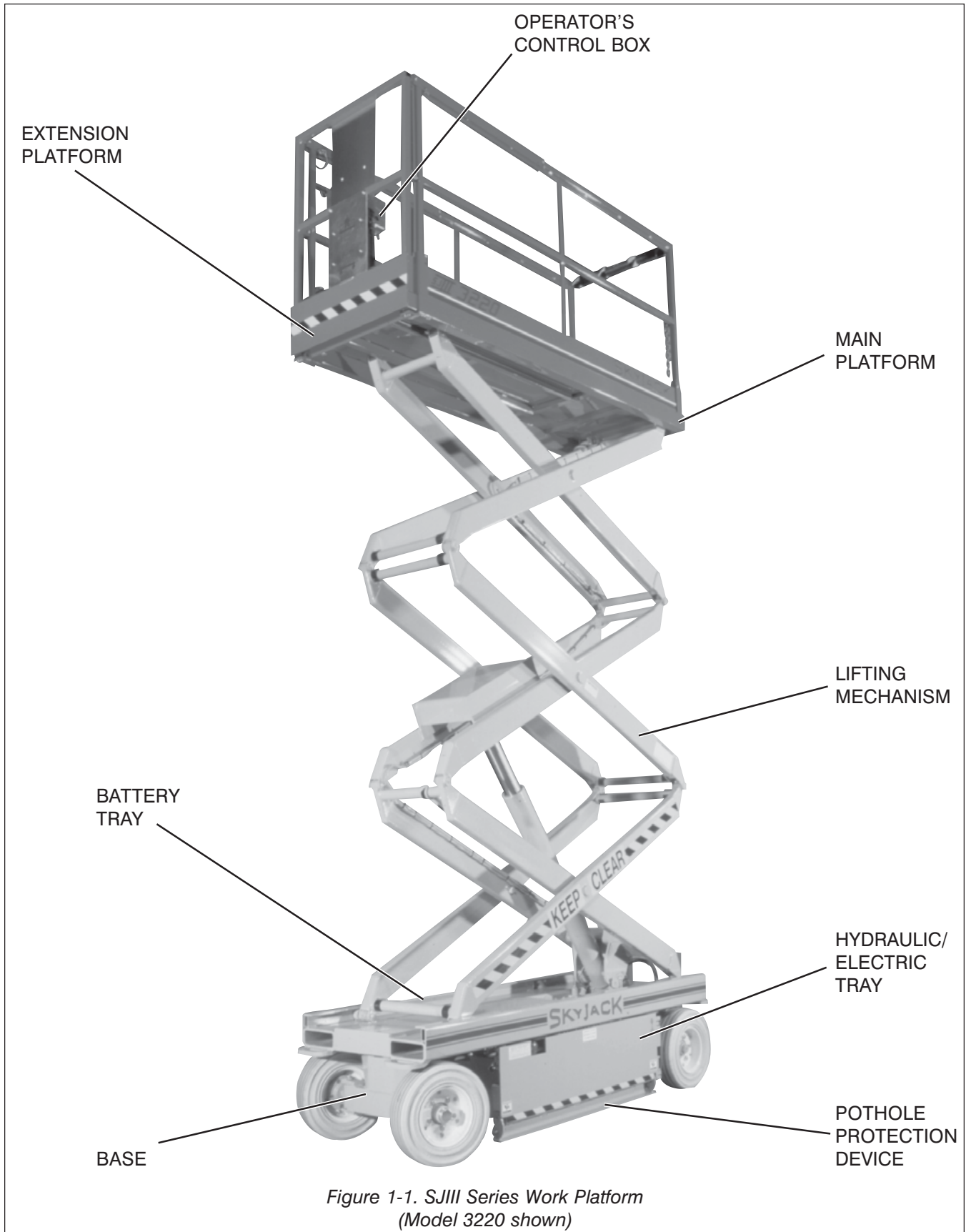

Figure 1-1. SJIII Series Work Platform  
(Model 3220 shown)

# SECTION 2 OPERATION

## Operating Controls Identification

The following descriptions are for identification, explanation and locating purposes only. A qualified operator **MUST** read and completely understand these descriptions before operating this work platform. Procedures for operating this work platform are detailed in the “**Operating Procedures**” section. Both standard and optional controls are identified in this section. Therefore, some controls may be included that are not furnished on your work platform.

## Base Controls

### Electrical Panel

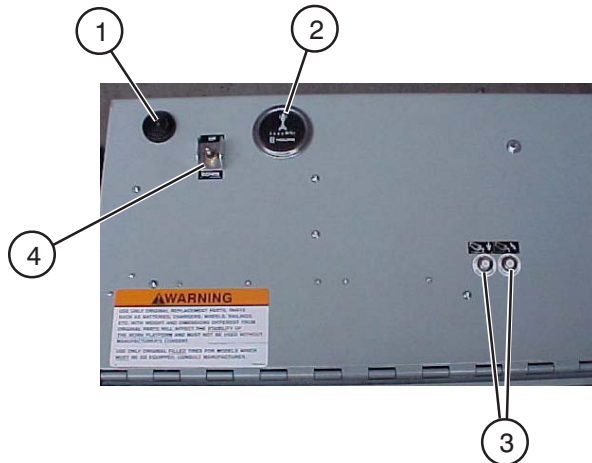

Figure 2-1. Electrical Panel

### Electrical Panel

This control station is located in the Hydraulic/Electric Tray. It contains the following controls:

- 1- Buzzer Alarm** - This audible pulse alarm sounds when platform is being electrically lowered. On machines with certain options, this alarm will sound when any control function is selected.
- 2- Hourmeter** - Activated when the pump/motor runs, this gauge records work platform operating time.
- 3- 15 Amp Circuit Breaker Resets** - In the event of a power overload or positive circuit grounding, circuit breaker will pop out. Make the necessary corrections, then depress the push-button to reset.
- 4- Up/Down Toggle Switch (ANSI and CSA)** This toggle type switch raises or lowers the platform to desired a height.

### Emergency Battery Disconnect Switch



Figure 2-2. Emergency Battery Disconnect Switch

- 1- Emergency Battery Disconnect Switch** - Located on the rear of the base, this switch, when in “OFF” position, disconnects power to all control and power circuits. Switch **MUST** be in “ON” position to operate any electric control circuit.

### Base Control Box (CE)

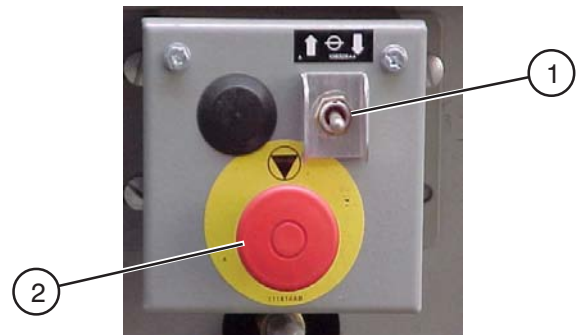

Figure 2-3. Base Control Box (CE)

### Base Control Box (CE)

This metal control station is mounted on the rear of the base. It contains the following controls:

- 1- Platform Up/Down Toggle Switch** - This toggle type switch raises or lowers the platform to a desired height.
- 2- Emergency Stop Button** - This red “mushroom-head” shaped button switch is designed to disengage power to the platform controls.

## Platform Controls

### Operator's Control Box

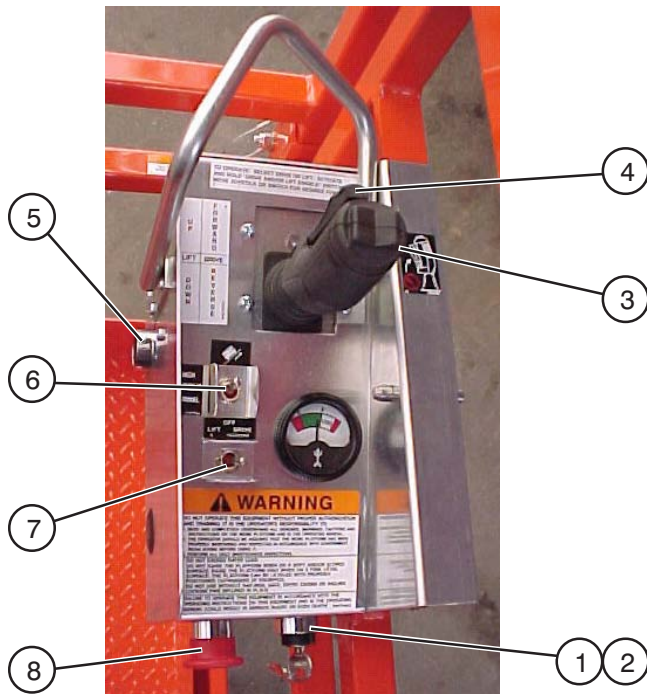

Figure 2-4. Operator's Control Box

#### Operator's Control Box

This metal control station is mounted at the right front of the platform. It contains the following controls:

- 1- Off/On Key Switch (ANSI and CSA)**- Disconnects or energizes the control circuit in the operator's control box.
- 2- Platform/Off/Base Select Key Switch (CE)** - This three-way selector switch allows the operator to turn off the power to the unit or to activate either the base or platform controls.
- 3- Proportional Controller** - A one-hand toggle-type lever to control proportional drive/lift motion. It is a "deadman" control which returns to neutral when released.
- 4- Lift/Drive Enable Switch** - This momentary "Trigger" style switch energizes the proportional controller. It must be held depressed continuously while engaging either the drive/lift or steer functions.
- 5- Operator Horn Push-Button** - This momentary push-button switch activates an automotive-type horn.

**6- High/Normal Torque Select Toggle Switch** - This switch selects "HIGH" torque (low speed) or "NORMAL" torque (high speed). (Models 3220, 3226, 4620, 4626, 4832, 6826 and 6832 only.)

**7- Lift/Off (If Equipped)/Drive Select Toggle Switch** - If "Lift" is selected, the lift circuit is energized. "OFF" (If Equipped) disconnects power from both the lift and drive circuits. If "DRIVE" is selected, the drive circuit is energized.

**8- Emergency Stop Button** - This red "mushroom-head" shaped button switch is designed to disengage power to the platform controls.

### Powered Extension Platform Control Box



Figure 2-5. Powered Extension Control Box

#### Powered Extension Platform Control Box

- 1- Enable Switch** - This switch, when activated, brings power to the Platform Extend/Retract Selector Switch.
- 2- Platform Extend/Retract Selector Switch** - This switch, when activated, extends or retracts the platform.

# Identification And Operation Of Safety Devices

## Safety Bar

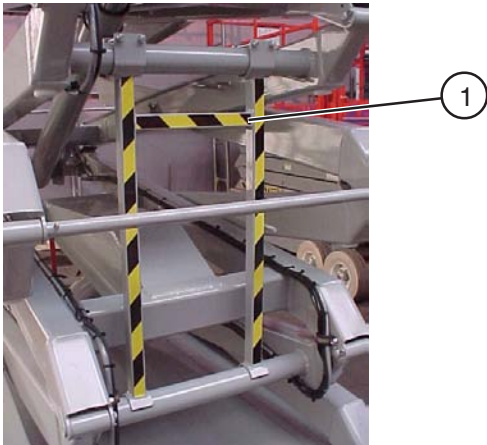

Figure 2-6. Safety Bar

**1- Safety Bar** - Designed to support the scissors assembly (when properly positioned), the safety bar **MUST** be used when inspecting or when performing maintenance or repairs within the scissor assembly with the platform raised. To use the safety bar, follow the procedure on the safety bar label on the base.

 **Warning**  
**Crushing Hazard**

**DO NOT** reach through the scissor assembly when the platform is raised without the safety bar properly positioned. Lower the platform until the scissor assembly is firmly supported by the safety bar. **Failure to avoid this hazard will result in death or serious injury!**

## Pothole Protection Device



Figure 2-7. Pothole Protection Device

**1- Pothole Protection Device** - This device consists of a mechanically actuated steel weldments, located under the hydraulic/electric tray and battery tray, these weldments will automatically rotate for reduced ground clearance when elevating the platform. If the pothole protection device has not fully lowered, the drive function will be disabled.

 **Warning**  
**Crushing Hazard**

Personnel on ground **MUST** stay clear of pothole protection bar.

 **Warning**

**DO NOT** drive elevated in areas where electrical cords or debris is in the path of travel.

**DO NOT** drive elevated into holes, depressions, trenches, shafts or soft or uneven ground.

**Maintenance of the Pothole Protection Device** - As with all safety devices, periodic inspection and maintenance is required to ensure the proper operation of the pothole protection device. This mechanism is designed to reduce ground clearance and assist in the stability of an elevated platform in the event the machine encounters a “Drop-off” or “Pothole”. The nature of this safety feature relies on maintaining a consistent ground clearance, therefore if the machine ever does come to rest on the Pothole device, the platform should be immediately lowered and “locked out” to prevent further use until a complete inspection of the mechanism is performed by a qualified technician.

## Fold-Down Guardrail System

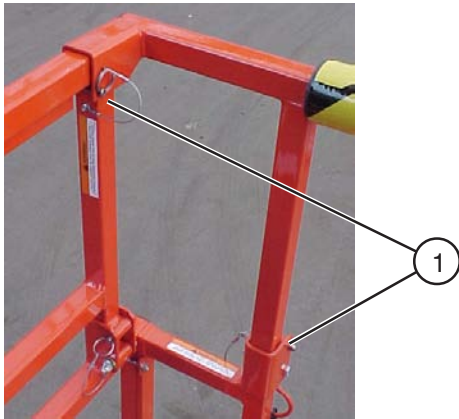

Figure 2-8. Fold-Down Guardrail System

### Fold-Down Guardrail System

This system when folded down, reduces the shut height of the work platform for travelling through standard doorways.

**1- Guardrail Locking Pin With Lanyard** - To fold the guardrail system down, remove the locking pin at each pivot point and lower each guardrail. To raise the guardrail system, swing up each guardrail and lock in place with the locking pins ensuring that the detent ball of each pin is clear of the side of the pivot brackets. (Figure 2-9.)

### **Warning**

The guardrail system **MUST** be upright and locked in place before resuming normal operation. **Check the guardrail system for loose or missing locking pins before operating this equipment!**

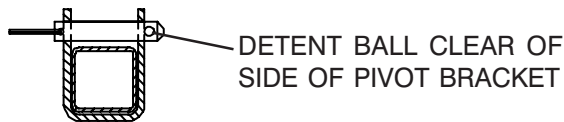

Figure 2-9. Correct Position of Locking Pin

## Operator Qualifications

Only trained and authorized persons should use this work platform. Safe use of this work platform requires the operator to understand the limitations and warnings, operating procedures and operator's responsibility for maintenance. Accordingly, the operator **MUST** understand and be familiar with this operating manual, its warnings and instructions and **ALL** warnings and instructions on the work platform. Operator also **MUST** be familiar with employer's work rules and related government regulations and be able to demonstrate his/her ability to understand and operate **THIS** make and model work platform in the presence of a qualified person.



# Operating Procedures

## Set-Up Procedure

1. Remove all packing materials and inspect for damage incurred during transport. This is normally required for equipment being put into service for the first time, after the equipment has been unloaded.

### Note

Report any damage to delivery carrier immediately.

2. Inspect work platform thoroughly and remove any foreign objects.
3. If equipped with a fold-down guardrail system, swing up and lock all guardrails in place with locking pins. (Refer to Figure 2-9).
4. Unlock and swing out the battery tray and hydraulic/electric tray.



### Warning Explosion Hazard

Keep flames and sparks away. **DO NOT** smoke near batteries.

### First Aid

Immediately flush eyes with cold water if electrolytic acid is splattered into them. Seek medical attention if discomfort continues.

5. In the battery tray, check the electrolyte level in all four batteries. If plates are not covered, carefully add distilled or demineralized water. If needed, check the specific gravity in each battery, it should be 1.260 to 1.275. (This reading will not be correct if you just added water to the batteries.)
6. Connect the A.C. battery charger cord to the proper A.C. voltage source and charge the batteries. (Refer to “Battery Charging Procedures”).
7. When charger cycle is complete, disconnect the battery charger A.C. cord and swing the battery tray to locked closed position.
8. In the hydraulic/electric tray, check the hydraulic oil level (scissors **MUST** be fully lowered) in the tank. Level should be at or slightly above the top mark on the gauge. If required, add a quality grade hydraulic oil such as ATF Dextron III (ESSO). Refer to the “HYDRAULIC OIL” label located on the oil reservoir for specific applications.
9. Swing the hydraulic/electric tray to locked closed position.
- 10A. **On (CE) machines:**  
Raise the platform, by selecting “BASE” position, with the Platform/Off/Base Select Switch (Figure 2-4.), then push the base Up/Down Toggle Switch to the “↑” (up) position until there is an adequate clearance to swing down and position the safety bar.
- 10B. **On ANSI and CSA machines:**  
Raise the platform with Up/Down Toggle Switch from the hydraulic tray, until there is an adequate clearance to swing down and position the safety bar.
11. Lift the Safety Bar from the storage channel and swing down into position. (Refer to label on base for proper procedure.) Lower the platform until the scissor assembly is firmly supported by the safety bar.

12. Inspect all hoses, fittings, wires, cables, valves, etc. for leaks, hidden damage and foreign material.

**13A. On (CE) machines:**

Raise the platform, by selecting "BASE" position, with the Platform/Off/Base Select Switch (Figure 2-4.), then push the base Up/Down Toggle Switch to the "↑" (up) position until there is an adequate clearance to swing up the safety bar. Return the safety bar to storage channel.

**13B. On ANSI and CSA machines:**

Raise the platform with Up/Down Toggle Switch from the hydraulic tray, until there is an adequate clearance to swing up safety bar. Return the safety bar to storage channel.

14. Raise the platform to the maximum extension height.

**Note**

Refer to Table 1-1. General Specifications (Section 1) for raise and lowering times.

15. Fully lower the platform.

**Note**

A lowering warning system is standard on (CE) Models 3015, 3219, 3220, 3226, 4620, 4626 and 4832. This system automatically stops the lowering function before reaching the fully retracted position and sounds an alarm. After the operator has released the down controls and checked that no person is near the scissors, the lowering function can reactivate. These machines do not have scissor guards.

16. The SJIII Series Work Platform is now ready for use by an authorized, qualified operator who has read and completely understands ALL of Section 2, OPERATION in this manual.

## Prestart Checks

1. Carefully read and completely understand ALL of Section 2, OPERATION in this manual and ALL warnings and instruction labels on the work platform.
2. Ensure that there are no obstacles around the work platform and in the path of travel such as holes, drop offs, ditches, soft fill or debris. Also ensure that there are no electrical cords and hoses with a diameter of more than 1/2" in the path of travel.
3. Check overhead clearances.
4. Make sure the batteries are fully charged. Disconnect the AC charger cord from the external power source.
5. Make sure that the Free-Wheeling Valve is fully closed.
6. Make sure all guardrails and lockpins are in place and locked in position
7. Make sure both side battery and hydraulic trays are closed and locked.
8. Make sure you do not climb or descend a grade steeper than 20% (3015, 3219 & 4832) or 25% (3220, 3226, 4620, 4626, 6826 & 6832). Elevated driving must only be done on firm level surfaces..

## **OPERATOR'S CHECKLIST**

### **INSPECT AND/OR TEST THE FOLLOWING DAILY OR AT BEGINNING OF EACH SHIFT**

- 1 OPERATING AND EMERGENCY CONTROLS.
- 2 SAFETY DEVICES AND LIMIT SWITCHES.
- 3 PERSONAL PROTECTIVE DEVICES.
- 4 TIRES AND WHEELS.
- 5 OUTRIGGERS (IF EQUIPPED) AND OTHER STRUCTURES.
- 6 AIR, HYDRAULIC AND FUEL SYSTEM(S) FOR LEAKS.
- 7 LOOSE OR MISSING PARTS.
- 8 CABLES AND WIRING HARNESSSES.
- 9 PLACARDS, WARNINGS, CONTROL MARKINGS AND OPERATING MANUALS.
- 10 GUARDRAIL SYSTEM INCLUDING LOCKING PINS.
- 11 ENGINE OIL LEVEL (IF SO EQUIPPED).
- 12 BATTERY FLUID LEVEL.
- 13 HYDRAULIC RESERVOIR LEVEL.
- 14 COOLANT LEVEL (IF SO EQUIPPED).

### **Warning**

**DO NOT OPERATE THIS EQUIPMENT WITHOUT PROPER AUTHORIZATION AND TRAINING. DEATH OR SERIOUS INJURY COULD RESULT FROM IMPROPER USE OF THIS EQUIPMENT!**

## **Start and Operation**

### ***Using the controls on the base:***

1. Turn Emergency Power Disconnect Switch to "ON" position. (CE rated machines pull out Emergency Stop Button located on Base Control Box.)
2. Use the ladder at the rear of the work platform to access the work platform deck.
3. Latch the entry chain/gate.

### ***Using the controls on the platform:***

### **Warning**

**TO PROTECT AGAINST UNINTENDED MOVEMENT OF THE WORK PLATFORM, PUSH IN THE EMERGENCY STOP BUTTON AFTER YOU HAVE ARRIVED AT YOUR DESIRED LOCATION OR ELEVATION.**

4. Pull out the Emergency Stop Button.
5. Turn key switch to "ON" position (ANSI and CSA) or "PLATFORM" position (CE).
6. **To Raise the Platform:**
  - 1- Ensure the emergency stop button is pulled out. Select "LIFT" position with the Lift/Off/Drive Toggle Switch.
  - 2- Activate and hold the Enable trigger switch (by squeezing it towards the joystick).
  - 3- Push the controller handle forward until desired height is reached.
  - 4- Return the joystick to the neutral center position to stop. Release the Enable trigger switch.

### **Note**

If the tilt alarm sounds and the platform does not, or only partially raises, immediately lower the platform and ensure that the machine is on a compacted **LEVEL** surface.

## Note

A lowering warning system is standard on (CE) Models 3220, 3226, 4620, 4626 and 4832. This system automatically stops the lowering function before reaching the fully lowered position and sounds an alarm. After the operator has checked that no person is near the scissors, the lowering function can be reactivated. These machines do not have scissor guards.

### 7. To Lower the Platform:

- 1- Ensure the emergency stop button is pulled out. Select "LIFT" position with the Lift/Off/Drive Toggle Switch.
- 2- Activate and hold the Enable trigger switch (by squeezing it towards the joystick).
- 3- Pull the controller handle backward until desired height is reached.
- 4- Return the joystick to the neutral center position to stop. Release the Enable trigger switch.

**Note:** Platform lowering is not proportional.

### 8. To Drive Forward or Reverse:

- 1- Ensure the emergency stop button is pulled out. Select "DRIVE" position with the Lift/Off/Drive Toggle Switch.
- 2- Activate and hold the Enable trigger switch (by squeezing it towards the joystick).
- 3- Push or pull the controller handle forward or backward to the desired speed and direction of platform travel.
- 4- Return the joystick to the neutral center position to stop. Release the Enable trigger switch.



## Warning

**IF THE MACHINE DOES NOT DRIVE WHEN ELEVATED, DISENGAGE THE DRIVE CONTROLLER. LOWER THE PLATFORM IMMEDIATELY. CHECK THAT THE POTHOLE PROTECTION DEVICE IS OPERATING PROPERLY, AND ENSURE THAT THERE ARE NO ELECTRICAL CORDS OR HOSES WITH A DIAMETER OF MORE THAN 1/2" (1.25 CM) IN THE PATH OF TRAVEL, OR UNDER THE POT HOLE PROTECTION BAR. ALSO, ENSURE THE MACHINE IS BEING OPERATED ON A COMPACTED, FIRM LEVEL SURFACE OR THE TILT SENSOR WILL DISABLE SOME OR ALL FUNCTIONS.**

9. **To Increase Drive Torque** - Toggle The "HIGH/NORMAL TORQUE" switch to select high torque (low speed) or normal torque (high speed). Select "HIGH" position when climbing grades or when loading or unloading the work platform, select "NORMAL" position when traveling on a level surface with the platform fully lowered.

10. **To Steer:** Select "DRIVE" position with the Lift/Off/Drive Toggle Switch. Activate and hold the Enable trigger switch (by squeezing it towards the joystick), then press the rocker on top of the controller handle in the direction you wish to steer.

**Note:** Steering is not proportional.

11. **To Sound the Horn:** Depress the horn push-button located on the side of the operator's platform control box.

12. **To Extend/Retract the Manual Extension Platform:** Remove the locking pin(s) and push/pull the extension deck using the sliding handrails or push-bar (Models 68XX). Reinsert the locking pin(s) upon full retraction or extension to prevent accidental movement of the extension platform.

13. **To Extend/Retract the Powered Extension Platform:** To extend the platform, select "LIFT" position with Lift/Off/Drive Select Switch then push this selector switch to "↑" (extend) position until desired extension is reached. Release switch to stop. To retract the platform, select "LIFT" position with Lift/Off/Drive Select Switch then push the selector switch to "↓" (retract) position until desired retraction is reached. Release switch to stop. The "Enable" switch must be activated simultaneously with the extension/retraction switch in order for the platform to operate.

## Note

All models are drivable with any extension platform extended 3 feet or less. An interlock limit switch cuts out drive when the platform is extended beyond 3 feet.

## Emergency Lowering System

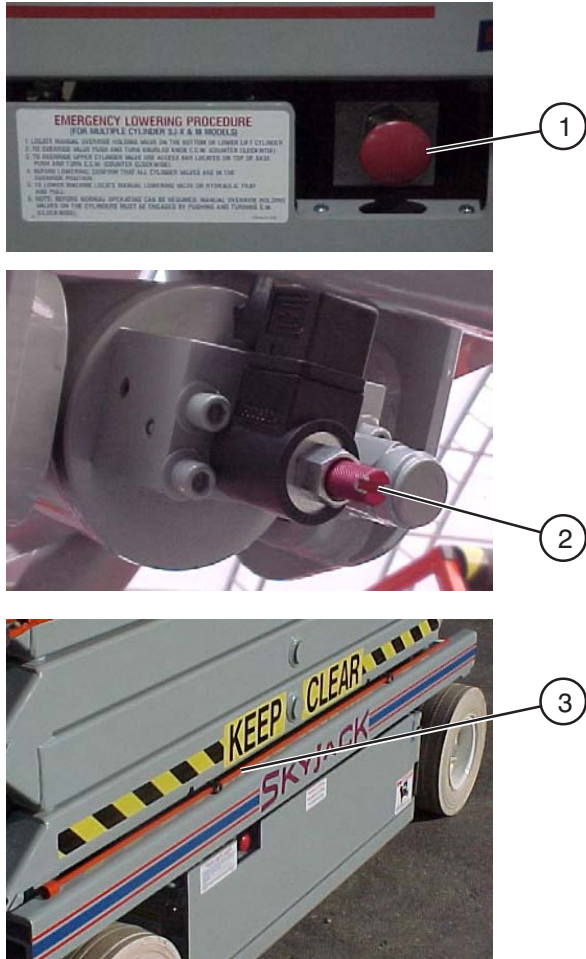

Figure 2-10. Emergency Lowering System

### Emergency Lowering Valve and Holding Valve Manual Override Knob

This system allows platform lowering in the event of an electrical system failure. Use the following procedure to lower the platform:

1. Turn Main Disconnect Switch to “OFF” position.
2. Depress and turn each red manual override knob (**Item 2**) (located at the base of each lift cylinder) counterclockwise. Override knobs on the upper cylinders of multiple cylinder machines can be reached with the access rod (**Item 3**) stored on top of the base.
3. Pull the Emergency Lowering Valve (**Item 1**) out to lower the platform.
4. Turn each red manual override knob (**Item 2**) clockwise to restore normal operation.

## Shutdown Procedure

1. Fully lower the platform.
2. Turn Key Switch to “OFF” position. Remove key.
3. Push in Emergency Stop Button.
4. Rotate Emergency Battery Disconnect Switch to “OFF” position. (On CE machines also push in Emergency Stop Button located on Base Control Box.)

## Winching and Towing Procedures

### Warning

When towing, **DO NOT** drive onto a downward slope or brake the towing vehicle rapidly.

### Preparation For Winching Or Towing

#### a) Parking Brake

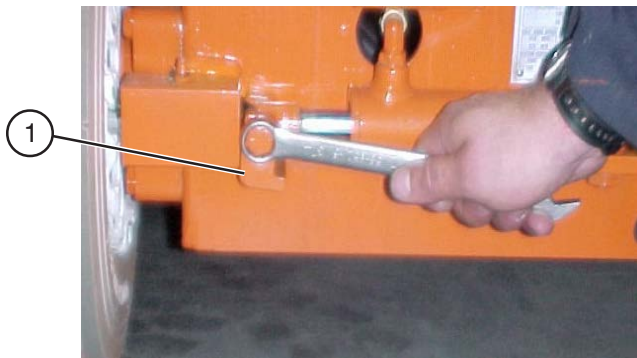

Figure 2-11. Parking Brake

**1- Parking Brake** - The parking brakes are devices that are always mechanically engaged until hydraulically or manually released. A pin retracted by a single-acting hydraulic cylinder disengages each brake disc when driving. A spring inside each cylinder returns the pin to engage the brake disc for parking, lifting, lowering and stationary steering. The brake pins **MUST** be manually disengaged for pushing, towing or winching. **DO NOT push or tow the work platform onto a downward slope or pull the platform down an incline towards the winch.** The special procedure for manually disengaging the parking brakes is as follows:

### Warning

**DO NOT** manually disengage the parking brakes if the work platform is on a slope.

Make sure that the work platform is on level ground. Chock or block the wheels to keep work platform from rolling.

- **For Left-Hand Brake:** Using a 3/4" wrench, rotate the lock-out block on the brake pin 90° clockwise. The brake pin should be clear of the brake disc.
- **For Right-Hand Brake:** Using a 3/4" wrench, rotate the lock-out block on the brake pin 90° counterclockwise. The brake pin should be clear of the brake disc.

### Note

The parking brakes will reset automatically when the work platform is driven.

## b) Free-Wheeling Valve



(Models 3220, 3226, 4620, 4626, 4832, 6826 and 6832- Located at the rear of the base)



(Models 3015 and 3219- Located at the front of the base)

Figure 2-12. Free-Wheeling Valve

**1- Free-Wheeling Valve** - The free-wheeling valve is located at the front or rear of the machine. Turning the valve knob counterclockwise to a fully opened position allows fluid to flow through the wheel motors, thus providing “free-wheeling” so that the work platform can be pushed, towed or winched after the brakes are released (Figure 2-11) without damaging the wheel motors. **When pushing, towing or winching, DO NOT exceed 2 mph (3.2 km/h). DO NOT push or tow the platform onto a downward slope or pull the platform down an incline towards the winch.** The Free-wheeling valve **MUST** be closed tightly (clockwise) for normal operation.

## c) Preparation After Winching or Towing

After moving machine, complete the following procedures:

1. Position machine on a firm, level surface.
2. Chock or block the wheels to keep work platform from rolling, or engage the parking brake by momentarily activating the drive function.
3. Close free-wheeling valve

## Battery Service and Charging Procedures

### Battery Service

 **Warning**  
**Explosion Hazard**

Keep flames and sparks away. **DO NOT** smoke near batteries.

 **Caution**

Contact with electrolytic acid can cause skin irritation and damage clothing. Wear a protective apron, gloves and goggles when working with batteries.

### Servicing the Batteries

1. Turn Emergency Battery Disconnect Switch to “OFF” position.
2. Check battery case for damage.
3. Check battery fluid level in each battery. If plates are not covered by at least 1/2” (13mm) of solution, add distilled or demineralized water.
4. Clean battery terminals and cable ends thoroughly with a terminal cleaning tool or wire brush.
5. Make sure all battery connections are tight.
6. Replace any battery that is damaged or incapable of holding a lasting charge.
7. Do not use any batteries other than flooded lead-acid batteries of the proper AH rating.

### First Aid

Immediately flush eyes with cold water if electrolytic acid is splattered into them. Seek medical attention if discomfort continues.

## Battery Charging Procedures

### EE-Rated Machines

 **Warning**

**DO NOT CHARGE BATTERIES IN HAZARDOUS AREA! THE EE-RATING OF A MACHINE DOES NOT INCLUDE THE CHARGING OF BATTERIES.**

1. Move the work platform to an area designated for battery charging. (Refer to NFPA 505\* for charging set-up.) \*NFPA 505 is a publication of: **National Fire Protection Association, Inc.** Batterymarch Park, Quincy, MA 02269 (USA)
2. Connect battery charger DC plug into the battery plug at the rear of the base.
3. Charge batteries. (Refer to battery charger operation manual for procedures.) When charge cycle is completed, disconnect charger plug from battery tray.



## Standard Machines

 **Warning**  
**Explosion Hazard**

Charges can ignite flammable materials and vapors. **DO NOT** use near fuels, grain dust, solvents or other flammables.

 **Warning**  
**Shock Hazard**

To reduce the risk of electrical shock, the charger must only be connected to properly grounded single phase outlet. The AC circuit protection should not exceed 15 amperes. The extension cord used **must** be a three wire grounded cord of at least 14 AWG. **DO NOT** use an extension cord longer than 25 feet (7.6m). Inspect AC charger's receptacle for the presence of water from washing or storage. Dry thoroughly prior to use.

1. Check for a firm AC connection at the charger receptacle. Connect the charger cord to the AC wall plug to turn the charger on. Refer to charger nameplate for voltage requirements.
2. Charge batteries. **DO NOT** leave charger unattended for more than two consecutive days. Severe overcharging and battery damage will result if charger fails to turn off.
3. Disconnect charger from external power source.

## Battery Charger Operation

### Battery Charger 2.1

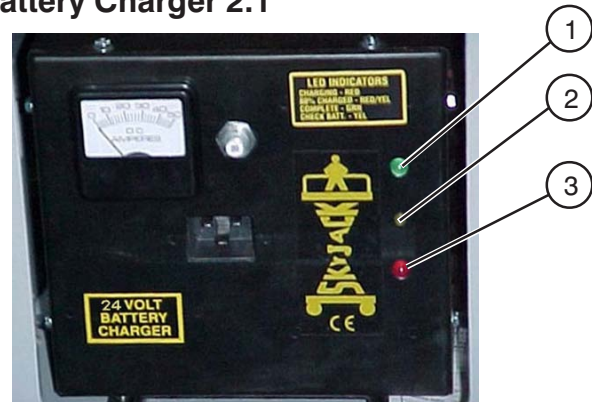

Figure 2-13. Bycan Battery Charger (SK2440E Shown)

- 1 Green LED
- 2 Yellow LED
- 3 Red LED

### Battery Status (SK 2440A/SK 2440E)

Green LED ..... Complete  
Yellow LED ..... Check Battery  
Red LED ..... In Progress

### Battery Status (SK 2440U)

Red LED . ..... Charging  
Red/Yellow LED ..... 80% Charged  
Green LED ..... Complete  
Yellow LED ..... Check Battery

Apply The AC power. The charger will start immediately (the transformer will hum and fan will come on). The red LED will come on. The ammeter will show charging current.

The current will be high for approximately 30 minutes then it will taper off. If the current does not taper off, disconnect the charger and check the batteries for a shorted cell.

When the battery bank voltage reaches approximately 30 volts DC, the yellow flashing LED will illuminate. This indicates that the charger has now entered a timed equalizing cycle. After completing the 3.5 hour cycle, the charger will shut off and the green LED will come on to indicate a complete charge.

If a shorted battery cell prevents the charger from raising the battery voltage to approximately 30 VDC to start the equalization timer, a second timer will shut down the charger after 16 hours of continuous charging. When this happens, the flashing yellow LED will come on to notify the user that the battery bank should be inspected for a shorted/damaged cell.

## Battery Charger 2.2

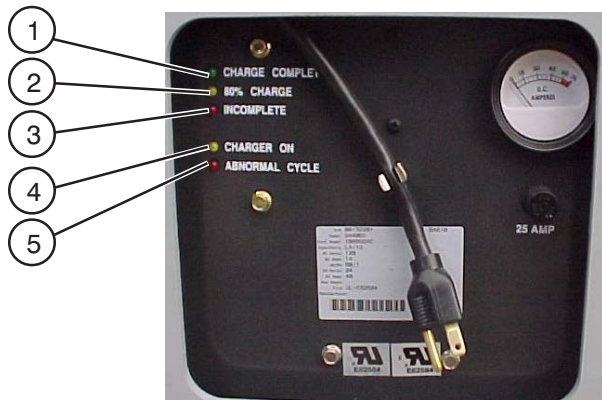

Figure 2-14. MAC Charger

### Battery Status

- 1 GREEN L.E.D. .... CHARGE COMPLETE
- 2 YELLOW L.E.D. .... 80% CHARGE
- 3 RED L.E.D. .... INCOMPLETE

### Charger Status

- 4 YELLOW L.E.D. .... CHARGER ON
- 5 RED L.E.D. .... ABNORMAL CYCLE

This charger is equipped with an electronic circuit that will completely recharge the batteries and automatically turn off after the charge cycle is complete.

The function of the L.E.D. indicators is as follows:

When the AC power is connected to the charger, the L.E.D.'s will flash several times then flash independently to check the light circuits. After the flashing sequence is complete the "INCOMPLETE" light will come on. Five seconds later, the "CHARGER ON" light will come on and at the same time, the ammeter will indicate how much current is going to the batteries.

As the charge cycle continues, which can last between 1 1/2 hours and 16 hours for a complete cycle, depending on the state of charge of the batteries, the "80%" light will come on and the "INCOMPLETE" light will go off. When voltage of the batteries reaches approximately 30 volts, the "80%" light will go off and the "CHARGE COMPLETE" light will come on. This light will remain on even after the charger is turned off by the electronic control. After the charger turns off, the "CHARGE COMPLETE" light will indicate to the operator that the batteries are fully charged.

If the "80% CHARGE" light continues to stay on after the charge cycle is complete, this indicates to the operator that the batteries are not capable of attaining a full charge.

If the "INCOMPLETE" light remains on after the charge cycle is complete, this indicates to the operator that the batteries are not capable of attaining even an 80% charge.

If either the "80% CHARGE" or "INCOMPLETE" light remain on after the charge cycle is complete, the batteries should be inspected for problems.

Refer to the "Battery Service" section for proper battery inspection and maintenance procedures.

## Battery Charger 2.3

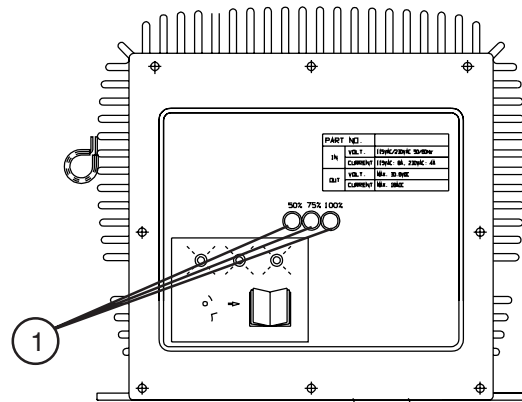

Figure 2-15. Battery Charger 2.3

- 1- State of charge indicator LEDs

### Operation Of Charger 2.3



Risk of electric shock. Do not immerse the charger in water. Though the charger is highly resistant to water, it is not designed for immersion and an electric shock can occur.

- 1 Provide adequate ventilation for the batteries and charger. The convection cooled design requires access to cooling air for proper operation. Do not allow blankets or other materials to cover the charger. Though the charger protects itself against overheating, the charger cooling fins should be cleaned if clogged with debris for best performance.

 **Warning**

There could be a spark during charging. Be careful when using fuels, solvents or other flammables near the charger or batteries.

2. Connect the power supply cord to a properly grounded 100V/50 or 60Hz, 115V/ 60Hz, or 230V/ 50 or 60Hz socket. This charger automatically senses and adjusts to the AC input voltage range.

 **Caution**

When changing the input voltage wait until all the LED's are OFF or wait a minimum of 20 seconds before switching on the new voltage.

3. The charging time is affected by numerous factors including battery Amp-Hour capacity, depth of discharge, battery temperature, and battery condition (new, old, or defective). Batteries larger than 240 Ah can be recharged but will take longer.

 **Danger**

Do not disconnect the DC output wires near the batteries when the charger is ON. The resulting arcing could cause the batteries to explode. If the charger must be disconnected, first disconnect the AC power supply cord from its outlet, then disconnect the charger DC connections.

 **Danger**

Risk of an electric shock. Do not touch un-insulated parts of the charger output wires, battery connector, or battery terminals.

 **Danger**

Visually and manually inspect to verify the DC output wires and terminals are in good working condition before each use.

4. The charger will start automatically within four to six seconds. The charger will start even with severely discharged batteries (down to 1V terminal voltage). Once charging starts, the LED's indicate the charging progress.

### Charging State LED

State of charge	1 <sup>ST</sup> LED	2 <sup>ND</sup> LED	3 <sup>RD</sup> LED
0 to 50%	Blinking	Off	Off
50% to 75%	On	Blinking	Off
75% to 100%	On	On	Blinking
100%	On	On	On

The charger goes into an equalizing charge mode after the batteries are charged and all 3 LEDs are "ON". The charger will continue to charge at a low current then shut-off automatically when complete.

If all 3 LEDs blink together, there is a problem. Take proper action according to the following instructions:

**3 LEDs blink once simultaneously:** Output connection error. Check the battery and charger connection. The output may not be connected to the batteries or the connections to the batteries may have corroded or loosened. The output may be shorted due to improper connection to the batteries or pinched wires. The output may be connected in reverse polarity to the batteries. The charger is not damaged by any of these problems.

**3 LEDs blink twice simultaneously:** The charger is indicating that the AC voltage is too low or too high. Check the AC input voltage.

**3 LEDs blink three times simultaneously:** Charger is overheated. No action required. When the charger cools, charging will re-start automatically. Check and correct for dirt or other debris on charger that may be reducing cooling.

**3 LEDs blink four times simultaneously:** Input or output over current. No action required, charger will correct and re-start automatically.

**Batteries do not fully charge.** If the batteries are charged overnight, make sure the ac supply is not being switched-off at night with other building items. Check battery condition and for dead cells or reduced capacity. Replace charger only if other problems are not found.

**The AC line circuit breaker or fuse is blown.** A defective circuit breaker or fuse, an overloaded circuit, or a charger problem can cause this condition. Try connecting the charger to a different AC outlet (on a different circuit) in the building. If the ac supply checks good, the charger should be replaced.

**Table 2-1. Owner's Annual Inspection Record**

MODEL NUMBER _____				SERIAL NUMBER _____				
RECORDING DATE								
RECORDING YEAR #	1	2	3	4	5	6	7	8
OWNER'S NAME								
INSPECTED BY								

**Table 2-2. Maximum Platform Capacities (Evenly Distributed)**

MODEL	With 3' Extension Platform				With Powered Extension Platform			
	Main Platform		Extension Platform		Main Platform		Extension Platform	
3015	250 lbs. (113 kg)	1 Persons	250 lbs. (113 kg)	1 Person	250 lbs. (113 kg)	1 Persons	250 lbs. (113 kg)	1 Person
3219	250 lbs. (113 kg)	1 Persons	250 lbs. (113 kg)	1 Person	250 lbs. (113 kg)	1 Persons	250 lbs. (113 kg)	1 Person
3220	500 lbs. (226 kg)	2 Persons	300 lbs. (136 kg.)	1 Person	400 lbs. (181 kg.)	2 Persons	300 lbs. (136 kg.)	1 Person
3226	250 lbs. (113 kg)	1 Persons	250 lbs. (113 kg)	1 Person	Not Applicable	Not Applicable	Not Applicable	Not Applicable
4620	800 lbs. (362 kg)	2 Persons	300 lbs. (136 kg.)	1 Person	700 lbs. (317 kg.)	2 Persons	300 lbs. (136 kg.)	1 Person
4626	550 lbs. (249 kg.)	2 Persons	300 lbs. (136 kg.)	1 Person	450 lbs. (204 kg.)	2 Persons	300 lbs. (136 kg.)	1 Person
4832	400 lbs. (181 kg.)	2 Persons	300 lbs. (136 kg.)	1 Person	Not Applicable	Not Applicable	Not Applicable	Not Applicable
6826 (ANSI & CSA)	900 lbs. (408 kg.)	2 Persons	300 lbs. (136 kg.)	1 Person	700 lbs. (317 kg.)	2 Persons	300 lbs. (136 kg.)	1 Person
6826 (CE)	700 lbs.* (317 kg.)	2 Persons	300 lbs. (136 kg.)	1 Person	700 lbs. (317 kg.)	2 Persons	300 lbs. (136 kg.)	1 Person
6832	550 lbs.** (249 kg.)	2 Persons	300 lbs. (136 kg.)	1 Person	550 lbs.** (249 kg.)	2 Persons	300 lbs. (136 kg.)	1 Person

\* Main platform capacity was 900 lbs (408 kg) on CE models with serial #75598 and below.

\*\* Overall capacity is increased by 150lbs (68 kg.) on CSA and CE Models.

**NOTE:** Overall capacity - Occupants and materials not to exceed rated load.

**Table 2-3. Maintenance And Inspection Schedule**

	Daily	Weekly	Monthly	3 Months	6 Months	12 Months*
<b>Mechanical</b>						
Structural damage/welds	A					A
Parking brake	B					B
Tires/wheels & fasteners	A, B & C					A, B & C
Guides/ rollers & slider pads	A, B & I					A, B & I
Railings & railing lock pins	A & C					A & C
Entry chains or gates	B & C					B & C
Bolts and fasteners	C					C
Safety Bar	B					B
Rust			A			A
Wheel Bearings & King pins	A, B & E					A, B & E
Pothole Protection	A & B					A & B
Steering cylinder & tie rod				A, B & E		A, B & E
<b>Electrical</b>						
Battery fluid level	A					A
Control switches	A & B					A & B
Cords & wiring	A					A
Battery terminals	A & C					A & C
Terminals & plugs	C					C
Generator/receptacle	A & B					A & B
Limit switches	B					B
<b>Hydraulic</b>						
Hydraulic oil level	H					H
Hydraulic Hoses/Fittings	A & L	C				A, C & L
Lift/lowering time				G		G
Cylinders		A & B				A & B
Emergency lowering	B					B
Lift capacity			D			D
Hydraulic oil & oil filter					F	F
<b>Miscellaneous</b>						
Manual	A & K					A & K
Labels	A & J					A & J
<b>Notes</b>						
A. Visually Inspect. B. Check operation. C. Check tightness. D. Check relief valve setting. Refer to serial number nameplate. E. Lubricate. F. Replace. G. <a href="#">Refer to table 1-1 specifications and features.</a> H. Check oil level.			I. Ensure there is no metal to metal contact with slider, slider side or running surface. Check for free movement of surface. Also check for free movement of the slider pin through the slider. J. Replace if missing or illegible. K. Proper manual must be in box. L. Check For Leaks. * Record inspection date and signature.			

**Table 2-4A. Floor Loading Pressure (SJIII Conventionals)**

MODELS		3220		3226		4620		4626		4832		6826		6832	
WEIGHT	lbs	3900 (min)	4700 (max)	4720 (min)	5250 (max)	3660 (min)	4760 (max)	4870 (min)	5720 (max)	5280 (min)	5980 (max)	5220 (min)	6420 (max)	5870 (min)	7070 (max)
	kg	1769 (min)	2132 (max)	2141 (min)	2381 (max)	1660 (min)	2159 (max)	2209 (min)	2595 (max)	2395 (min)	2713 (max)	2368 (min)	2912 (max)	2663 (min)	3207 (max)
LCP	psi	101	97	Not Available	114	98	95	97	94	110	102	78	84	82	94
	kg/cm <sup>2</sup>	7.10	6.82	Not Available	8.02	6.89	6.68	6.82	6.61	7.73	7.17	5.48	5.91	5.77	6.61
OUP	psf	197.28	237.60	Not Available	265.5	128.16	167.04	171.36	201.60	178.56	201.60	112.32	136.80	125.28	151.2
	kN/m <sup>2</sup>	9.45	11.38	Not Available	12.71	6.14	8.00	8.21	9.66	8.55	9.66	5.38	6.55	6.00	7.24

**Table 2-4B. Floor Loading Pressure (SJIII Compacts)**

MODELS		3015		3219	
WEIGHT	lbs	2360 (min)	2860 (max)	2790 (min)	3290 (max)
	kg	1071 (min)	1297 (max)	1266 (min)	1492 (max)
LCP	psi	77	93	86	101
	kg/cm <sup>2</sup>	5.41	6.54	6.05	7.10
OUP	psf	178.39	216.19	197.71	233.15
	kN/m <sup>2</sup>	8.54	10.35	9.47	11.17

**Local Concentrated Pressure (LCP)**

Local Concentrated Pressure should be taken into account when the machine is used on surfaces which could be damaged.

**Local Concentrated Pressure (LCP):**

**Foot Print Area** = Length x Width

$$LCP = \frac{\text{Weight of Machine} + \text{Capacity (Lbs)}}{\text{Foot Print Area} \times 4 \text{ (Tires)}}$$

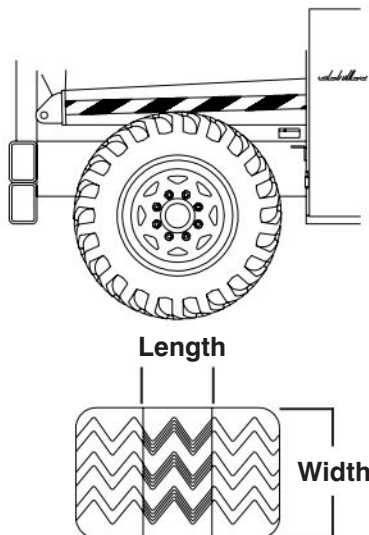

**Overall Uniform Pressure (OUP)**

Overall Uniform Pressure should be taken into account when the machine is used on surfaces that are beam supported. The allowable pressure must not be exceeded for reasons of safety.

**Overall Uniform Pressure (OUP):**

**Base Area** = Length x Width

$$OUP = \frac{\text{Weight of Machine} + \text{Capacity}}{\text{Base Area}}$$

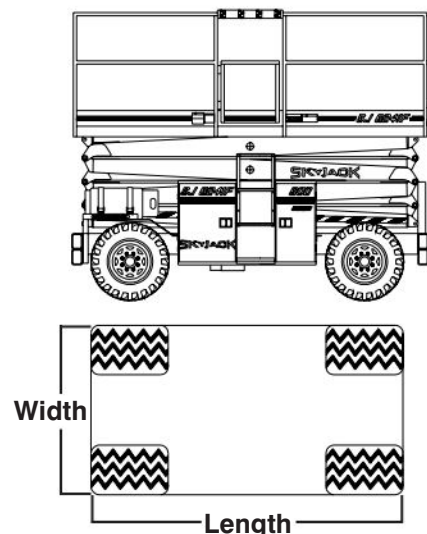

**Table 2-5. SJIII Special Option Information**

Option Sheet Part #	Description
125034	Switch Option, Pressure
125037	Battery Tray Option, SJIII Conventional Removable
125042	Button Hole deck & Base Control Box Options (SJIII 6832EE)
125043	Control Box Cable Extension Option (SJIII 4626)
125048	Scissor Guard Option, SJIII 3220 & 4626 French
125049	Dual Flashing Light Option, SJIII 3220, 4626 & 4830
125052	Battery Tray, SJIII 4626 Removable
125053	Side Entrance Option, SJIII 3220
125054	Extension Deck Entrance Option, SJIII 4626
125055	Extra Capacity Powered Extension Deck Option, SJIII 4620
125056	Side Extension Deck Option, SJIII 3218
125058	Side Extension Deck Option, SJIII 4620
125059	Extension Deck Hinged Gate Option, SJIII 4626
125060	Aircraft Padding Option, SJIII 6832
125061	Aircraft Padding Option, SJIII 4626
125062	Narrow Platform Option, SJIII 3220
125069	800 Watt Generator Option, SJIII
125070	Aircraft padding, SJIII 4620 & 6832
125071	Power Deck Cutout, SJIII All Function
125072	Freezer Option, SJIII
125083	Drive Cutout For North America - SJIII



**Warning**

The Above List Is For Customers That Wish To Obtain Information About Special Options That Are Already On Their Machines. If You Wish To Know Which Options May Be Added To Your Machine, Contact The SKYJACK Service Department At 800 275-9522 or Fax 630 262-0006. Include The Model and Serial Number For Each Applicable Machine.

**Table 2-6. Limit Switch Settings**



**Warning**

**DO NOT USE A PLATFORM THAT DOES NOT COMPLY WITH THESE PARAMETERS!**

Heights indicated are measurements made on a on a flat level surface from the ground to the elevated platform floor. Activation points are to be determined on the upward travel, or a rising work platform.

Activation Height Settings for Drive Cutout Limit Switches*				
Model	Drive cutout (All machines can be driven at full height except as noted)			
	ANSI & CSA		CE	
	Feet	Meters	Feet	Meters
3015	-	-	-	-
3219	-	-	-	-
3220	-	-	-	-
3226	-	-	-	-
4620	-	-	16*	4.9*
4626	-	-	24*	7.3*
4832	-	-	26	7.9
6826	-	-	23	7.0
6832	26*	7.9*	23	7.0

\* Models equipped as "Dual Power Pack Ready" or are equipped with a "Dual Power Pack" only.

# SKYJACK

**ELEVATING THE WORLD**

[www.skyjackinc.com](http://www.skyjackinc.com)